

# Service Facts

## Single Packaged Heat Pump

4WCA4048C1000A

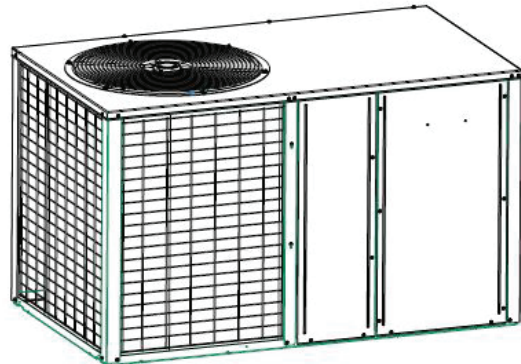

*Note: "Graphics in this document are for representation only. Actual model may differ in appearance."*

### **▲ SAFETY WARNING**

Only qualified personnel should install and service the equipment. The installation, starting up, and servicing of heating, ventilating, and air-conditioning equipment can be hazardous and requires specific knowledge and training. Improperly installed, adjusted or altered equipment by an unqualified person could result in death or serious injury. When working on the equipment, observe all precautions in the literature and on the tags, stickers, and labels that are attached to the equipment.

# SAFETY SECTION

**Important** — This document contains a wiring diagram, a parts list, and service information. This is customer property and is to remain with this unit. Please return to service information pack upon completion of work.

## ⚠ WARNING

### HAZARDOUS VOLTAGE!

Failure to follow this Warning could result in property damage, severe personal injury, or death.

Disconnect all electric power, including remote disconnects before servicing. Follow proper lockout/tagout procedures to ensure the power cannot be inadvertently energized.

## ⚠ WARNING

### SAFETY AND ELECTRICAL HAZARD!

Failure to follow this Warning could result in property damage, severe personal injury, or death.

These servicing instructions are for use by qualified personnel only. To reduce the risk of electrical shock, do not perform any servicing other than that contained in these operating instructions unless you are qualified to do so.

## ⚠ CAUTION

### GROUNDING REQUIRED!

Failure to inspect or use proper service tools may result in equipment damage or personal injury. Reconnect all grounding devices. All parts of this product that are capable of conducting electrical current are grounded. If grounding wires, screws, straps, clips, nuts, or washers used to complete a path to ground are removed for service, they must be returned to their original position and properly fastened.

## ⚠ WARNING

### UNIT CONTAINS R-410A REFRIGERANT!

Failure to use proper service tools may result in equipment damage or personal injury.

R-410A operating pressure exceeds the limit of R-22. Proper service equipment is required. Service using only R-410A Refrigerant and approved POE compressor oil.

## ⚠ WARNING

### SAFETY HAZARD!

Operating the unit without the access panels properly installed may result in severe personal injury or death.

Do not operate the unit without the evaporator fan access panel or evaporator coil access panel in place.

## ⚠ WARNING

### WARNING!

This product can expose you to chemicals including lead, which are known to the State of California to cause cancer and birth defects or other reproductive harm. For more information go to [www.P65Warnings.ca.gov](http://www.P65Warnings.ca.gov).

**Important:** Wear appropriate gloves, arm sleeve protectors and eye protection when servicing or maintaining this equipment.

**Important:** Air filters and media wheels or plates shall meet the test requirements in UL 900.

# Product Specifications

<b>MODEL</b>	4WCA4048C1000A
RATED Volts/PH/Hz	208-230/1/60
Performance Cooling BTUH <sup>(a)</sup>	46500
Indoor Airflow (CFM)	1400
Power Input (KW)	4.09
EER2/SEER2 (BTU/Watt-Hr.) <sup>(b)</sup>	10.6/13.4
Sound Power Rating [dB(A)] <sup>(c)</sup>	78.7
<b>PERFORMANCE HEATING</b>	
(High Temp.) BTUH	44500
Power Input (KW)	3.42
(Low Temp.) BTUH	24400
Power Input (KW)	3.37
HSPF2 (BTUH/Watt-Hr)	6.7
<b>POWER CONN. — V/Ph/Hz</b>	208/230/1/60
Min. Brch. Cir. Ampacity <sup>(d)</sup>	35
Fuse Size — Max. (amps)	50
Fuse Size — Recmd. (amps)	50
<b>COMPRESSOR</b>	SCROLL
VOLTS/PH/HZ	208/230/1/60
R.L. Amps — L.R. Amps	19.6/130.0
<b>OUTDOOR COIL — TYPE</b>	PLATE FIN
Rows/F.P.I	2/18
Face Area (sq. ft.)	15.6
Tube Size (in.)	5/16
Refrigerant Control	EXPANSION VALVE
<b>INDOOR COIL — TYPE</b>	PLATE FIN
Rows/F.P.I	4/16
Face Area (sq. ft.)	5.43
Tube Size (in.)	5/16
Refrigeration Control	EXPANSION VALVE
Drain Conn. Size (in.)	3/4 MALE NPT
<b>OUTDOOR FAN — TYPE</b>	PROPELLER

DIA. (IN.)	23
DRIVE/NO. SPEEDS	DIRECT / 1
CFM @ 0.0 in. w.g. <sup>(e)</sup>	3780
Motor — HP/R.P.M	1/4 / 1075
Volts/Ph/Hz	200/230/ 1 / 60
F.L. Amps/L.R Amps	1.28/2.85
<b>INDOOR FAN — TYPE</b>	CENTRIFUGAL
Dia. x Width (in.)	11 X 11
Drive/No. Speeds	DIRECT / 3
CFM @ 0.0 in. w.g. <sup>(f)</sup>	SEE FAN PERFORMANCE TABLE
Motor — HP/R.P.M.	3/4 / VARIABLE
Volts/Ph/Hz	208-230/1/60
F.L. Amps	6.3
<b>FILTER / FURNISHED</b>	NO
Type Recommended	THROWAWAY
Recmd. Face Area (sq. ft) <sup>(g)</sup>	5.3
<b>REFRIGERANT</b>	R-410A
Charge (lbs.)	7.9
<b>CHARGING SPECIFICATIONS</b>	
Subcooling	10°
<b>DIMENSIONS</b>	H X W X L
Crated (in.)	45 7/8 x 36 3/8 x 61 1/8
<b>WEIGHT</b>	
Shipping (lbs.) / Net (lbs.)	505

(a) Rated in accordance with AHRI Standard 210/240.

(b) Rated in accordance with D.O.E. test procedure.

(c) Sound Power values are not adjusted for AHRI 270-95 tonal corrections.

(d) Calculated in accordance with currently prevailing Nat'l Electrical Code.

(e) Standard Air — Dry Coil — Outdoor.

(f) Standard Air — Dry Coil — Indoor

(g) Filters must be installed in return air stream. Square footages listed are based on 300 f.p.m. face velocity. If permanent filters are used size per manufacturer's recommendation with a clean resistance of 0.05" W.C.

# Pressure Curves

Figure 1. 4WCA4048C1

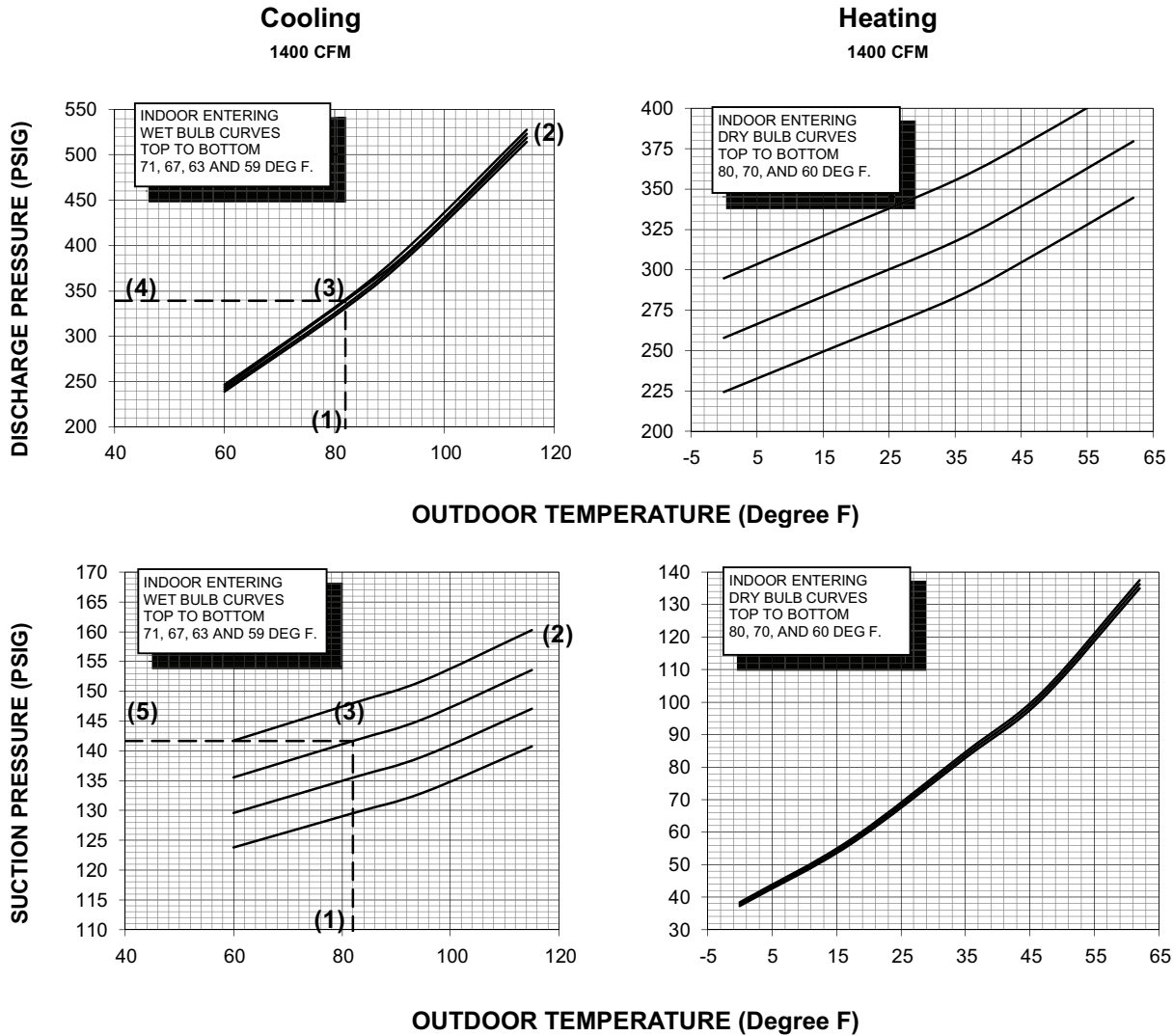

**COOLING PERFORMANCE CAN BE CHECKED WHEN THE OUTDOOR TEMP IS ABOVE 65 DEG F.**  
 TO CHECK COOLING PERFORMANCE, SELECT THE PROPER INDOOR CFM, ALLOW PRESSURES TO STABILIZE. MEASURE INDOOR WET BULB TEMPERATURE, OUTDOOR TEMPERATURE, DISCHARGE AND SUCTION PRESSURES. ON THE PLOTS LOCATE OUTDOOR TEMPERATURE (1); LOCATE INDOOR WET BULB (2); FIND INTERSECTION OF OD TEMP. & ID W.B. (3); READ DISCHARGE OR SUCTION PRESSURE IN LEFT COLUMN (4).

- EXAMPLE: (1) OUTDOOR TEMP. 82 F.  
 (2) INDOOR WET BULB 67 F.  
 (3) AT INTERSECTION  
 (4) DISCHARGE PRESSURE @ 1400 CFM CFM IS 339 PSIG.  
 (5) SUCTION PRESSURE @ 1400 CFM CFM IS 142 PSIG.

ACTUAL:  
 DISCHARGE PRESSURE SHOULD BE +/- 10 PSI OF CHART  
 SUCTION PRESSURE SHOULD BE +/- 3 PSIG OF CHART

DWG.NO. 4WCA4048C1

# Charging in Cooling above 55°F OD Ambient

If servicing the equipment requires system evacuation, then re-charge the system to the weight specified on the nameplate. Verify the system subcooling using the Subcooling Charging Table and, if necessary, adjust the charge using the procedure below.

1. For best results — the indoor temperature should be kept between 70°F to 80°F. Add system heat if needed.
2. Whenever charge is removed or added, the system must be operated for a minimum of 20 minutes to stabilize before accurate measurements can be made.
3. Measure Liquid Line Temperature and Refrigerant Pressure at service valved in the compressor compartment.
4. Locate your liquid line temperature in the left column of the table, and the intersecting liquid line pressure under the subcool value column, Add

refrigerant to raise the pressure to match the table, or remove refrigerant to lower the pressure. Again, wait 20 minutes for the system conditions to stabilize before adjusting charge again.

**Note:** System charge shall never be more than 110% or less than 90% of nameplate charge. If specified subcooling cannot be achieved within those charge bounds, contact your Field Service Representative.

5. When system is correctly charged, you can refer to System Pressure Curves to verify typical performance.

## CHARGING BELOW 55°F

Evacuate system and weigh in nameplate charge or use factory charge. Correct subcooling may be verified when the temperature is above 55°F.

<b>R-410A REFRIGERANT CHARGING CHART</b>									
<b>Refer to Service Facts or Installer's Guide for charging method</b>									
LIQUID TEMP (°F)	DESIGN SUBCOOLING (°F)								
	6	8	9	10	11	12	13	14	16
	LIQUID GAGE PRESSURE (PSI)								
55	174	179	182	185	188	191	195	198	205
60	189	195	198	201	204	208	211	215	222
65	205	211	215	218	222	225	229	232	240
70	222	229	232	236	240	243	247	251	259
75	240	247	251	255	259	263	267	271	279
80	259	267	271	275	279	283	287	291	301
85	279	287	291	296	300	304	309	313	323
90	301	309	313	318	322	327	331	336	347
95	323	331	336	341	346	351	355	360	371
100	347	355	360	365	370	376	381	386	398
105	371	381	386	391	396	402	407	413	425
110	398	407	413	418	424	429	435	441	454
115	425	435	441	446	452	458	464	470	484
120	454	464	470	476	482	488	495	501	516
125	484	495	501	507	514	520	527	533	549

From Dwg. D154557P01

## Charging Below 55°F OD Ambient in Heating Only

1. The Subcool Charging Method in cooling is NOT recommended below 55°F outdoor ambient.
2. The only recommended method of charging at outdoor ambients below 55°F, is to weigh in the charge in the heating mode.
3. Use Nameplate charge.

4. Check liquid line temperature and pressure (at the OD valves) to obtain a minimum of the subcooling shown in the subcooling table.
5. Add charge if the minimum subcooling as shown in the table is not obtained with the nameplate charge.
6. It is important to return in the spring or summer to accurately charge the system in the cooling mode at outdoor ambients above 55°F.

# Wiring Diagrams

Figure 2. 4WCA4048 Model Pg1

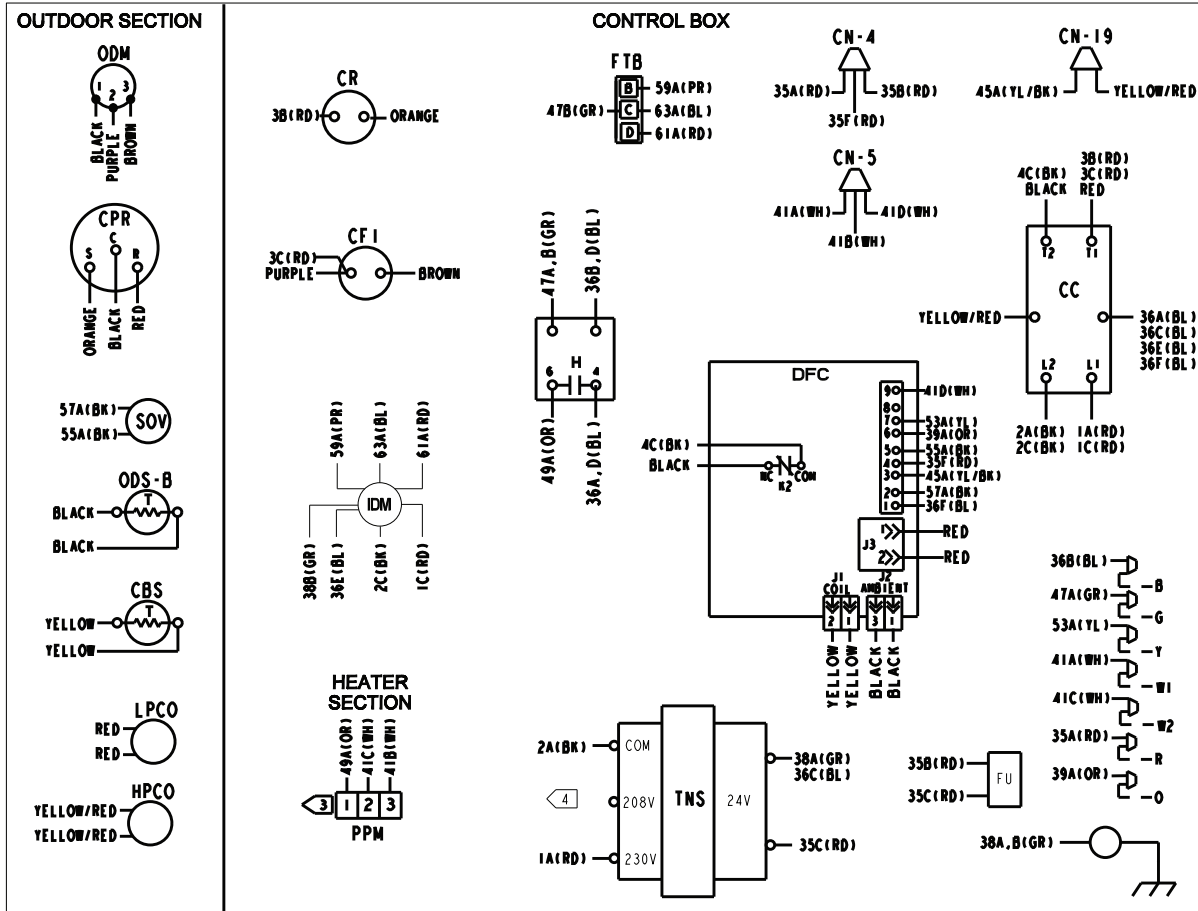

**NOTES:**

1. CONNECTIONS SHOWN ARE FOR A TYPICAL THERMOSTAT. SEE SCHEMATIC SUPPLIED WITH THERMOSTAT FOR PROPER CONNECTIONS. LOW VOLTAGE WIRING TO UNIT MAY BE NEC CLASS 2 AND MUST BE A MINIMUM OF 18 AWG.
2. MAXIMUM ADDITIONAL EXTERNAL LOAD (PILOT DUTY) BETWEEN "B" AND "R" OF 0.5 AMPS, 24 VAC IS AVAILABLE WHEN A HEATER IS INSTALLED.
3. SEE WIRING DIAGRAM WITH HEATER FOR DETAILS OF HEATER WIRING.
4. FOR 208 VOLT OPERATION MAKE THE FOLLOWING WIRING CHANGES: AT TNS, REMOVE ID(RD) WIRE AND CONNECT TO 208V TERMINAL ON THE TRANSFORMER
5. IF ANY OF THE ORIGINAL WIRE AS SUPPLIED IN THIS UNIT MUST BE REPLACED, REPLACE IT WITH APPLIANCE WIRING MATERIAL RATED AT 105 °C.

24 VOLT TRANSFORMER FUSE  
REPLACEMENT FU 36 VOLT TYPE  
ATC-5 AMP

**WIRE COLOR DESIGNATION**

ABBR	COLOR	ABBR	COLOR
BK	BLACK	PR	PURPLE
BL	BLUE	RD	RED
BR	BROWN	WH	WHITE
GR	GREEN	YL	YELLOW
OR	ORANGE		

**LEGEND**

DEVICE DESIG	DESCRIPTION	LINE NUMBER
AH/BH	CONTACTORS/RELAYS	32
CBS	COIL BOTTOM SENSOR	25
CC	CONTACTOR	13,30
CFI	OUTDOOR FAN CAPACITOR	14
CPR	COMPRESSOR	12
CR	COMPRESSOR CAPACITOR	12
DFC	DEFROST BOARD	12,21
FTB	INDOOR FAN TERMINAL BOARD	36
FU	FUSE	21
H	ELECTRIC HEAT RELAY	34,35
HPCO	HIGH-PRESSURE CUTOFF	29
IDM	INDOOR FAN MOTOR	16,36
LPCO	LOW-PRESSURE CUTOFF	22
ODM	OD FAN MOTOR	14
ODS-B	OUTDOOR AMBIENT SENSOR	24
SOV	SWITCH-OVER VALVE	28
TNS	TRANSFORMER 208/230V TO 24V	17

- C = LOW VOLTAGE COMMON
- G = ALTERNATE GROUND LOCATION
- L = LINE VOLTAGE
- N = NEUTRAL
- 1 = LOW TAP
- 2 = MEDIUM TAP
- 3 = HIGH TAP
- 4 = NOT USED
- 5 = NOT USED

**IDM CONNECTION**

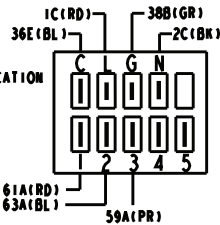
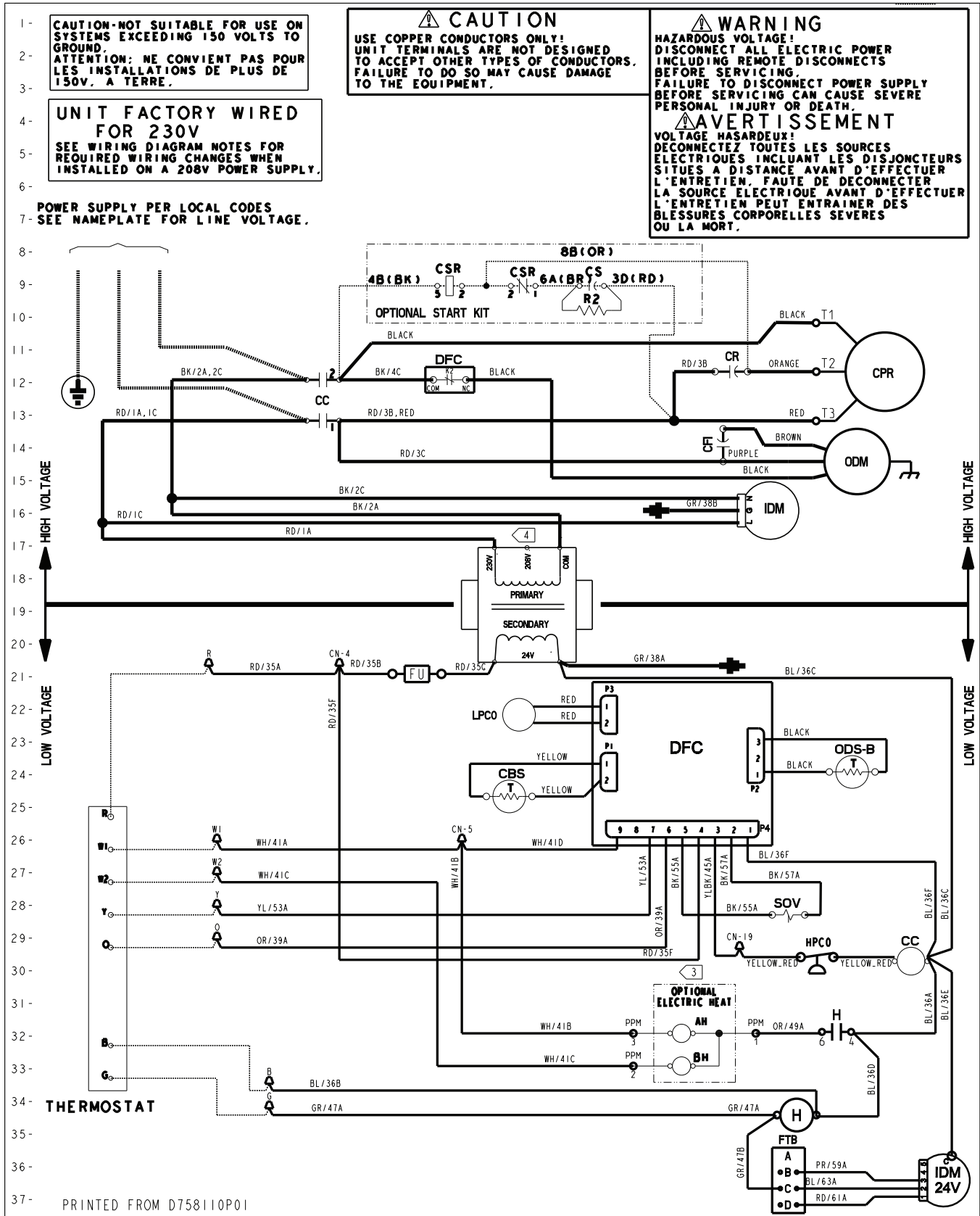
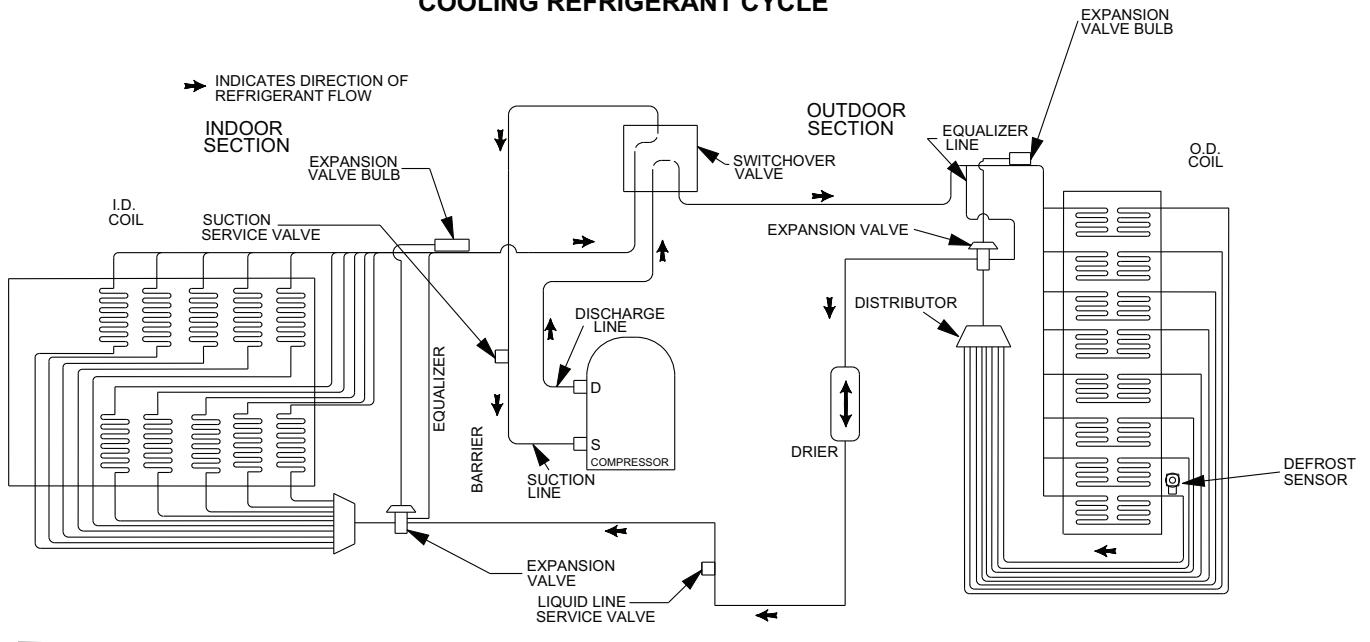

Figure 3. 4WCA4048 Model Pg2



# Refrigerant Circuit

## COOLING REFRIGERANT CYCLE



## HEATING REFRIGERANT CYCLE

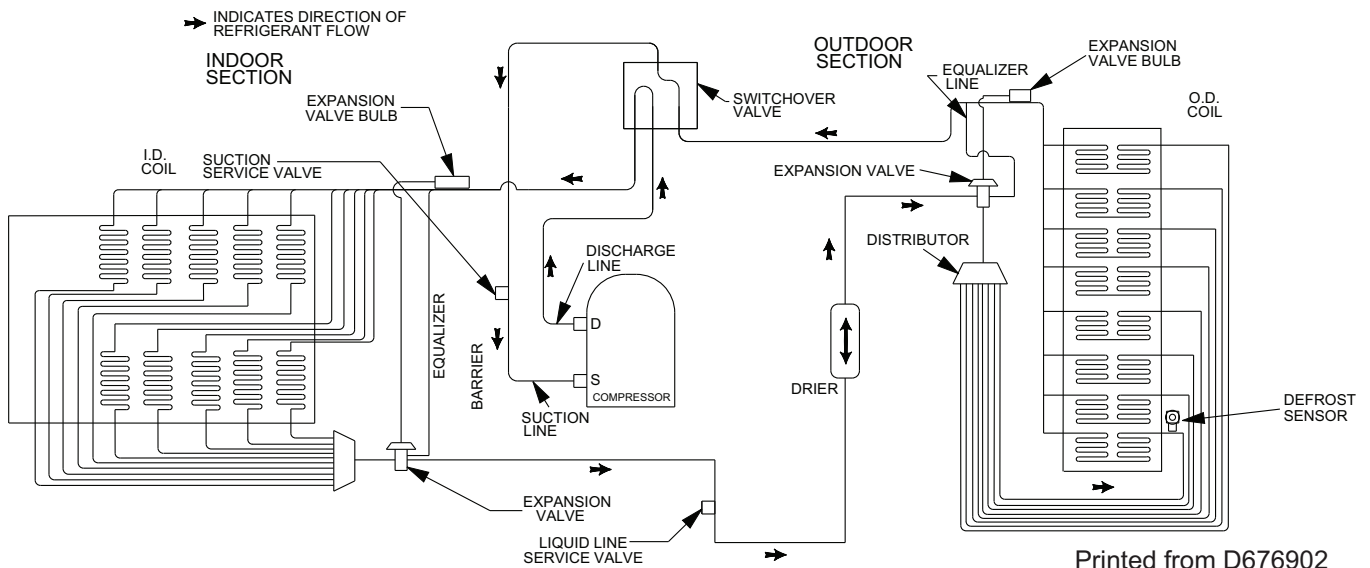

Printed from D676902



# Sequence of Operation

## General

Operation of the system heating and cooling cycles is automatic when the system is in the HEAT or COOL functions (the optional automatic changeover thermostat, when in the AUTO position, automatically changes to heat or cool with an appropriate room temperature change). The fan switch can be placed in the ON position, causing continuous evaporator (indoor) fan operation or placed in the AUTO position causing fan operation to coincide with heating or cooling run cycles.

## Cooling Mode

Note that the TSH and TSC are contacts that are internal to the indoor thermostat.

With the disconnect switch is in the ON position, current is supplied to the control transformer. The cooling cycle is enabled through the low voltage side of the control transformer to the "R" terminal on the indoor thermostat. With the system switch in the AUTO position and TSC-1 contacts closed, power is supplied to the "O" terminal on the indoor thermostat to the switch-over valve coil (SOV). This energizes the switch-over valve (SOV) and places it in the cooling position (it is in the heating position when de-energized).

When the indoor temperature rises 1–1/2 degrees, TSC-2 contacts close, supplying power to the "Y" terminal on the indoor thermostat, and to the compressor contactor (CC). This starts the outdoor fan motor and compressor. The TSC-2 contacts also provide power to the "G" terminal which provides power to the indoor fan motor.

## Heating Mode

With the disconnect switch in the ON position, current is supplied to the control transformer. Starting at the "R" terminal on the indoor thermostat, current goes through the system switch (which is in AUTO position) to the TSH-1 contacts. When closed, these contacts supply power to terminal "Y" on the indoor thermostat. Power is provided from "Y" to the compressor contactor (CC) which starts the compressor and outdoor fan motor. The indoor thermostat contact TSH-1 also provides power to "G" terminal on the indoor thermostat energizing the indoor fan motor.

## Supplementary Heat

The supplementary electric heat is brought on when the indoor temperature drops 1–1/2 degrees below the thermostat setting. TSH-2 contacts close providing power to the "W" terminal on the indoor thermostat and to the supplementary heater control circuit. An outdoor thermostat may have been added to disallow the second stage (if provided) of electric heat above a selected outdoor temperature. If the outdoor temperature falls below the setting on the outdoor thermostat this additional heater stage will come on. When the outdoor air temperature rises, and the outdoor T-stat setpoint is reached, the system will revert back to first stage electric heating.

When the indoor ambient is satisfied, TSH-2 contacts will open and the unit will revert back to the compressor only heating mode and then off. For **emergency heat** (use of supplementary electric heat only), and emergency (EMERG) heat switch is provided within the thermostat. When placed in the emergency heat position, it will disable the compressor, bypass the outdoor thermostats, if provided, and engage the supplementary electric heaters and indoor fan.

## Demand Defrost Operation

During the heating cycle, the outdoor coil may require a defrost cycle which is determined by the demand defrost control (DFC). This control continuously measures the outdoor coil temperature (CBS) and the outdoor ambient temperature (ODS-B) and calculates the difference or delta-T measurement. When the calculated delta-T is met, the demand defrost control (DFC) opens the circuit to the outdoor fan motor (ODM) and energizes the switch-over valve (SOV), placing the unit in the cooling mode to defrost the outdoor coil. The outdoor coil temperature sensor (CBS) terminates the defrost cycle, or times out after fifteen minutes in defrost, the (DFC) energizes the outdoor fan motor (ODM) and twelve seconds later de-energizes the (SOV), which returns the unit to the heating mode. Supplementary electric heat, if provided, is brought on to control indoor temperature during the defrost cycle.

### Maintenance

#### Owner Maintenance

Some of the periodic maintenance functions of the unit can be performed by the owner; this includes replacing the disposable or cleaning the permanent air filters, cleaning the unit cabinet, cleaning the condenser coil, and conducting a general unit inspection on a regular basis.

#### Filters

When the system is in constant operation, inspect the filters at least once each month.

If the unit has disposable-type filters, replace them with new filters of the same type and size. **Do not attempt to clean disposable filters.**

Permanent-type filters can be cleaned by washing them with a mild detergent and water. Make sure that the filters are thoroughly dry before reinstalling them in the unit (or duct system).

**Note:** *It may be necessary to replace permanent filters annually if washing fails to clean the filter or if the filter shows signs of deterioration. Be sure to use the same type and size as was originally installed.*

#### Condenser Coil

Be sure to keep all vegetation and debris away from the condenser coil area.

### Service Maintenance

#### Cooling Season

To keep the unit operating safely and efficiently, the manufacturer recommends that a qualified service technician check the entire system at least once each year or sooner if needed. The service technician should examine these areas of the unit:

- filters (for cleaning or replacement)
- motors and drive system components
- safety controls (for mechanical cleaning)
- electrical components and wiring (for possible replacement and connection tightness)
- condensate drain (for proper sealing and cleaning)
- unit duct connections (to see that they are physically sound and sealed to the unit casing)
- unit mounting support (for structural integrity)
- the unit (for obvious unit deterioration)

#### Heating Season

Complete the following unit inspections and service routines at the beginning of each heating season.

- Visually inspect the unit to ensure that the airflow required for combustion and condenser coil is not obstructed from the unit.
- Inspect the control panel wiring to verify that all electrical connections are tight and that the wire insulation is intact.

# DEFROST CONTROL

## Defrost Control

The demand defrost control measures heat pump outdoor ambient temperature with a sensor located outside the outdoor coil. A second sensor located on the outdoor coil is used to measure the coil temperature. The difference between the ambient and the colder coil temperature is the difference or delta-T measurement. This delta-T measurement is representative of the operating state and relative capacity of the heat pump system. Measuring the change in delta-T determines the need for defrost. The coil sensor also serves to sense outdoor coil temperature for termination of the defrost cycle.

## Fault Detection

A fault condition is indicated by the flashing Fault LED light on the defrost control board located inside the heat pump control box.

In normal operation, the status LED will flash once each second when idle or twice each second with a call for heating or cooling.

## PIN Identification

1. TEST\_COMMON (Shorting any of the other pins to this pin causes the function of the other pin to be executed. Leaving this pin open results in the normal mode of operation).
2. FRC\_DFT = Forced Defrost (Short TEST\_COMMON to this pin speeds up all defrost. Remove the short after defrost initiates).

## Defrost Control Checkout

Normal operation requires:

- a. Status LED on board flashing 1 time/second in standby or 2 times/second with a call for heating or cooling.
- b. 24V AC between R & B
- c. 24V AC between Y, Y0 & B with unit operating
- d. Defrost initiation when FRC\_DFT pin is shorted to TEST\_COMMON pin.

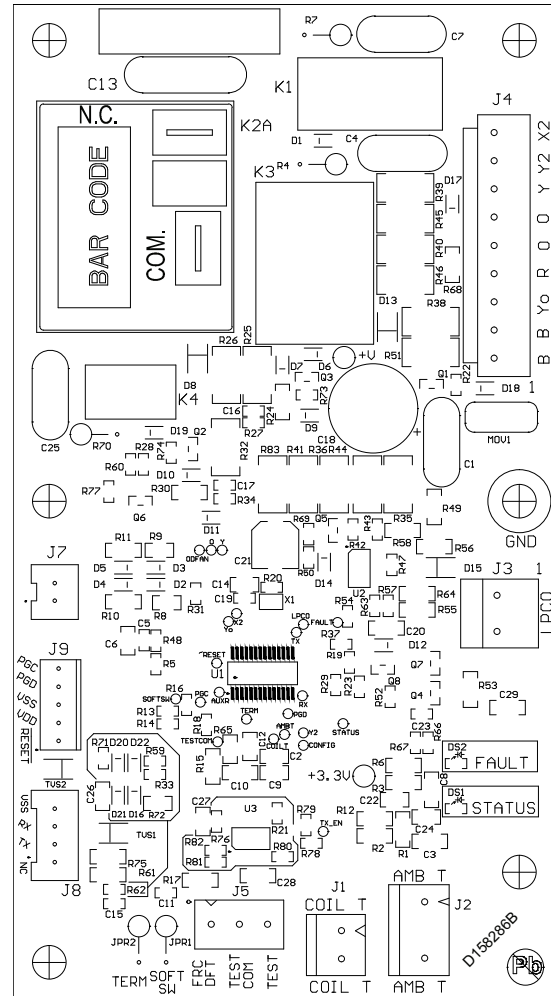

## Test Sensors

Measure the temperature the subject sensor is exposed to. If the sensor is mounted on a tube, place the lead on an Annie A-8 (or equiv.) temperature tester on the same tube near the sensor and insulate the bulb.

Unplug the sensor and measure the resistance with a good quality ohmmeter (Simpson 260 or equiv.). Read the value as quickly as possible to prevent the meter current from changing the resistance reading.

Using the chart in Table 1, p. 12, locate (as close as possible) the actual sensor temperature. The measured resistance should be relatively close to the resistance value shown in the chart.

# DEFROST CONTROL

**Table 1. Defrost Control Thermistor Table**

TEMP °F	TEMP °C	THERMISTOR RESISTANCE (OHMS)	Vo (Volts)
-15.00	-26.11	135976	2.50
-10.00	-23.33	115112	2.40
-5.00	-20.56	97745	2.29
0.00	-17.78	83247	2.17
5.00	-15.00	71108	2.05
10.00	-12.22	60916	1.93
15.00	-9.44	52333	1.81
20.00	-6.67	45076	1.69
25.00	-3.89	38927	1.56
30.00	-1.11	33703	1.45
35.00	1.67	29253	1.33
40.00	4.44	25452	1.22
45.00	7.22	22198	1.12
50.00	10.00	19405	1.02
55.00	12.78	17002	0.93
60.00	15.56	14930	0.85
65.00	18.33	13138	0.77
70.00	21.11	11586	0.70

**Table 1. Defrost Control Thermistor Table (continued)**

75.00	23.89	10238	0.63
80.00	26.67	9065	0.57
85.00	29.44	8043	0.52
90.00	32.22	7150	0.47
95.00	35.00	6368	0.42
100.00	37.78	5682	0.38
105.00	40.56	5079	0.35
110.00	43.33	4548	0.31
115.00	46.11	4079	0.28
120.00	48.89	3665	0.26
125.00	51.67	3298	0.23
130.00	54.44	2972	0.21
135.00	57.22	2683	0.19

Example:

Sensor temp. = 19°F

Measured Resistance = 46K ohms

This sensor is good since the measured value is relatively close to the chart value.

**Table 2. DEMAND DEFROST QUICK SPECS**

COMPRESSOR	SCROLL
MNEMONIC NO CNT	07824
GROUP NOMENCLATURE (a)	G01 / G04 / G06
SUPERSEDURE CNT	NA
OD FAN TYPE - PSC	PSC
	1-SPD
DEFROST ENABLED: Y = ON COIL TEMPERATURE =	≤52° F (b)
DEFROST PERMIT: Y = ON COIL TEMPERATURE =	≤32° F (b)
MIN DEFROST TIME (MINUTES)	1
TARGET DEFROST TIME (MINUTES)	4
MAX TIME OVERRIDE (MINUTES)	15
DEFROST TERMINATE COIL TEMPERATURE (Factory Setting)	47° F
DEFROST HI TERMINATE COIL TEMPERATURE (Cut Jumper 2)	70° F
SOV SWITCH-OVER DELAY AFTER DEFROST TERM. (SECONDS)	12
DEFEAT SWITCH-OVER DELAY (SECONDS) (Cut Jumper 2)	0
LOW AMBIENT HEAT PUMP LOCK OUT	-7° F
LOW AMBIENT HEAT PUMP RESUME	3° F
LPCO INPUT TO CONTROL	YES
LPCO BYPASS IN/OUT DEFROST (MINUTES)	3

(a) GROUP suffix for drawing number D159982

(b) ≤ (EQUAL OR LESS THAN)

**Table 3. LED FAULT CODES**

LED FAULT CODES	FAULT DESCRIPTION	DEFROST CONTROL BEHAVIOR
1 FLASH	Ambient Temp Sensor is out of range (open/shorted)	Initiate a 15 minute forced Defrost after every 60 minutes of runtime. See Note 1 & 2
2 FLASH	Coil Temp Sensor is out of range (open/shorted)	Initiate a 15 minute forced Defrost after every 60 minutes of runtime. See Note 2
3 FLASH	Low Pressure Switch is open	3 flash goes away when/if LPCO closes
4 FLASH	Hard Lock Out (can only be cleared with power cycle)	Occurs after 9th trip of LPCO. Note 6
5 FLASH	Soft Lock Out	5 flash goes away after soft lockout periods expires. See Note 2
6 FLASH	Defrost cycles too close together	Heating Short Cycle Fault triggers 6 flash & 5 flash codes. Follow Soft Lock-out sequence until Hard Lock-out (4 flash) or can clear if conditions no longer exist
7 FLASH	In Timed Defrost mode. Check Ambient sensor placement and verify SOV is operating properly.	Implied sensor fault (calibration/range) set after defrost and reset after 15 minutes run time after defrost. See Note 4
8 FLASH	In Timed Defrost mode. Check Coil sensor placement and verify SOV is operating properly.	Outdoor temperature is below -7° F. See Note 5.
9 FLASH	Low Ambient Soft Lock-out Outdoor temperature dropped below 3°F. (OFF at -7° F/ON at 3°F)	Outdoor temperature is below -7° F. See Note 5.

1. Initiate Adaptive/Timed Defrost so long as Coil Temp Sensor is functional. Monitor actual time in defrost and add or reduce run time until next forced defrost based on achieving a 4 minute (+/- 1) defrost period.
2. This Defrost control utilizes a safety method called "Inferred LPCO". If both Coil Temp Sensor and Ambient Temp Sensor have failed, initiate a 15 minute forced defrost after every 60 minutes of run time. This is in conjunction with the normal Low Pressure trip definitions. An "Inferred LPCO" trip is defined as: A heating cycle that enters defrost in 15 minutes or less and then enters another defrost in the same heating call within 15 minutes of the last defrost call -does not complete a learning algorithm. This could be caused by a condenser fan motor failure or other reasons. The first soft lockout occurs on the 4th defrost that was entered before the learning routine could complete in the same heating call. It is announced with a 5 flash and a 6 flash fault. After this first 15 minute soft lockout, the system will return to normal operation. Should this continue operating in this manner, there will be a 30 minute soft lockout and so on. At the end of the lockout process, if a hard lock is necessary —a flash will be announced and system operation is interrupted. If the ambient temperature climbs above 40 degrees F for more than 30 minutes, this clears this fault count and resumes normal operation.
3. Do not track if Y cycles off or if defrost takes 15 minutes (Max Time Override). Ambient Sensor reading is monitored at the end of defrost and should not deviate more than +/-5° F. Ambient Sensor must report a lower temperature than the Coil Sensor immediately after defrost (Coil Sensor should always be higher than Ambient Sensor when defrost terminates).
4. Do not track if Y cycles off or if defrost takes 15 minutes (Max Time Override). Coil Sensor reading is monitored at the end of defrost and reading must be less than Ambient Sensor after 15 minutes of run time.
5. Once ambient drops to -7° F or lower, wait 5 minutes before soft lockout begins. During soft lock out the Y signal passes through to the X2 output. Resume operation when ambient temperature rises to 3° F or higher and after a 15 minute soft lockout period expires.
6. During Hard Lockout, the X2 relay opens so that the Y signal does not pass through.

## DEFROST CONTROL

---

LPCO Inferred LPCO	HEATING Mode	Flash Code
1st Trip	15 minute soft lock-out period	5 and 6 flash
2nd Trip	30 minute soft lock-out period	5 and 6 flash
3rd Trip	45 minute soft lock-out period	5 and 6 flash
4th - 8th Trip	18 hour soft lock-out period	5 and 6 flash
9th Trip <sup>(a)</sup>	Hard lock-out	4 flash

<sup>(a)</sup> If LPCO is open, a 3 flash can accommodate any of the faults above and will clear when the LPCO closes.

LPCO	COOLING Mode	Flash Code
1st Trip	15 minute soft lock-out period	5 and 6 flash
2nd Trip	30 minute soft lock-out period	5 and 6 flash
3rd Trip	45 minute soft lock-out period	5 and 6 flash
4th - 8th Trip	18 hour soft lock-out period	5 and 6 flash

\* Once the LPCO closes, the 3 flash fault will not continue showing — only 5 flash if in the soft lock-out period.

# Indoor Fan Performance (230v)

**Table 4. Heater Table**

Heater	Minimum Heater Airflow CFM
	4WCA4048C1000A
BAYHTR1V05LUGAA	1400
BAYHTR1H08LUGAA	1400
BAYHTR1H10LUGAA	1400
BAYHTR1H15BRKAA	1400

**Table 5. Airflow Table**

4WCA4048C	ESP	0.1	0.2	0.3	0.4	0.5	0.6	0.7	0.8	0.9	1
<b>Low</b>	CFM	1673	1596	1515	1441	1372					
	WATTS	348	365	380	393	404					
<b>Medium</b>	CFM	1842	1772	1706	1605	1530	1459	1414			
	WATTS	445	465	483	502	517	529	539			
<b>High</b>	CFM			1794	1721	1658	1590	1530	1475	1432	1391
	WATTS			550	568	583	597	609	620	628	638

**Note:** Airflow must not exceed 1800 CFM due to condensate blowoff.

# Troubleshooting Chart

P-PRIMARY CAUSES / S-SECONDARY CAUSES

SYSTEM FAULTS	Power Supply	High Voltage Wiring	Compr. IOL	Run Capacitor	Start capacitor	Start Relay	Contactors Contacts	Low Voltage Wiring	Control Transformer	Contactor Coil	Low Voltage Fuse	Stuck Compressor	Ineffecient Compressor	Refrigerant Undercharge	Refrigerant Overcharge	Excessive Evap. Load	Noncondensables	Restricted O.D. Airflow	O.D. Air Recirculation	TXV Stuck Open	Low Superheat	High Superheat	Restricted I.D. Airflow	Ref. Circuit Restrictions
<b>REFRIGERANT CIRCUIT</b>																								
Liquid Pressure too High															P		S	P	S					S
Liquid Pressure too Low												S	P							S		S		S
Suction Pressure too High												S		P	P					S	S			
Suction Pressure too Low													S									S	P	S
Liquid Refrigerant Floodback (TXV System)																				S	S		P	
I.D. Coil Frosting														P							S		P	S
Compressor Runs Inadequate or No Cooling												S	P		P	S	S	S				S	P	S
<b>ELECTRICAL</b>																								
Compressor & O.D. Fan Do Not Start	P	P					S	S	P	P	P													
Compressor will not Start but O.D. Fan Runs		P	S	P	P	P						S												
O.D. Fan will Not Start		P		P																				
Compressor Hums but will Not Start		P		P	P	P	S					S												
Compressor Cycles on IOL		P	S	P	P	P	S					P	S	P	S	S	S	S	S				S	S
I.D. Blower will not Start	P	S						S	P		P													



# Important Product Information

Registering your products helps provide you with one of the strongest manufacturer limited warranties available. To register, go to the manufacturer's website or contact your dealer. You will need the serial number, model number, and installation date for each product being registered. Your dealer may have included these

on your invoice or can provide a list for you to use. Please take a few moments to record the following information to ensure your product registration process is quick and easy:

Packaged Unit Serial Number \_\_\_\_\_

Packaged Unit Model Number \_\_\_\_\_

Date of Installation \_\_\_\_\_

Dealer \_\_\_\_\_

## Service Information

Call your installing dealer if the unit is inoperative. Before you call, always check the following to be sure service is required:

1. Be sure the main switch that supplies power to the unit is in the ON position.
2. Replace any burned-out fuses or reset circuit breakers.
3. Be sure the thermostat is properly set.

Service Phone \_\_\_\_\_





## About Trane and American Standard Heating and Air Conditioning

Trane and American Standard create comfortable, energy efficient indoor environments for residential applications. For more information, please visit [www.trane.com](http://www.trane.com) or [www.americanstandardair.com](http://www.americanstandardair.com).

---



The AHRI Certified mark indicates company participation in the AHRI Certification program. For verification of individual certified products, go to [ahridirectory.org](http://ahridirectory.org).

The manufacturer has a policy of continuous data improvement and it reserves the right to change design and specifications without notice. We are committed to using environmentally conscious print practices.